

# GÜHRING

THE **SPECIALISTS** FOR  
**TROCHOIDAL MILLING**

HIGH CUTTING SPEED  
HIGH METAL REMOVAL RATE  
LOW WEAR

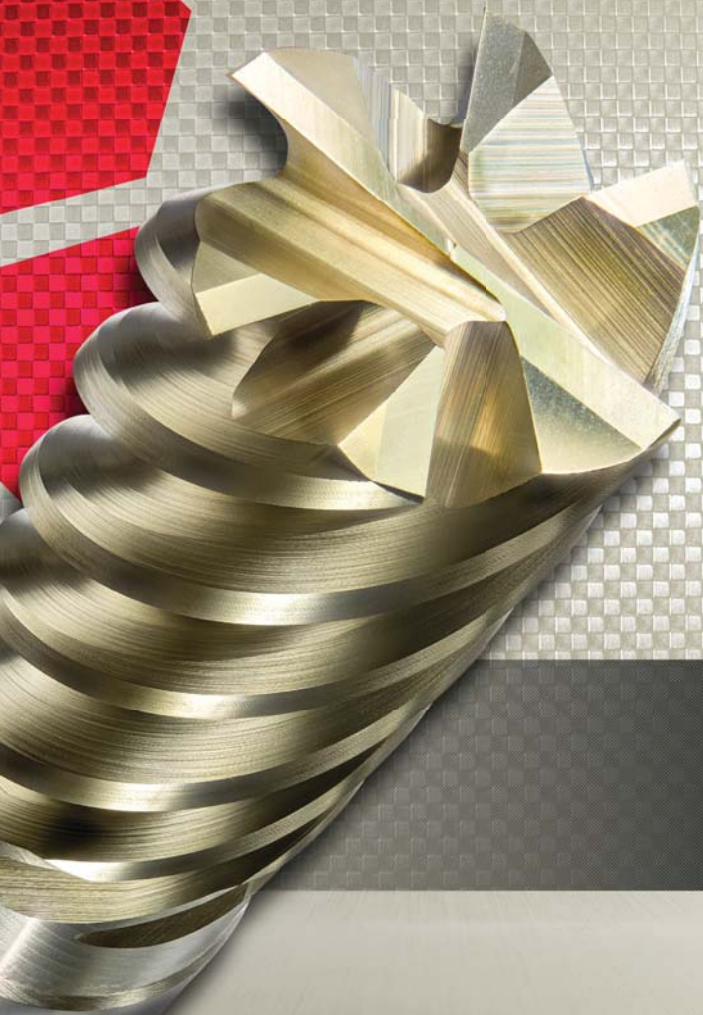

## GTC milling cutters

GÜHRING – YOUR WORLDWIDE PARTNER

# RF 100 SPEED

// Ratio® //

**48° helix angle** with unequal cutting edge partitioning for soft, quiet cut

**optimised chip gullet** deepened flute on front cutting edge area for improved chip evacuation

**stable cutting edge corner** thanks to corner protection chamfer and face correction



RF 100 Speed extra length's **chip breakers** in the cutting edges ensure short chips for secure evacuation in automated processes. The load on the machine is clearly reduced and the volume performance increased thanks to the light cut.



## YOUR ADVANTAGES AT A GLANCE

- // high-performance roughing even at high cutting depths
- // great running smoothness and high metal removal rate
- // GTC milling in different steel and cast iron grades and special alloys

# NEW

**RF 100 Speed P** for steel, high strength steel and cast materials  
**RF 100 Speed M** for soft tough and stainless steels and special alloys



GTC machining  
in a wide variety of materials

RF 100 Speed P and RF 100 Speed M | page 8



For soft and tough materials,  
high-tensile and difficult-to-machine  
special materials

RF 100 iMill and RF 100 Ti | page 12-15 and 20-23



Machining of steel materials,  
titanium and stainless steels

RF 100 Raptor | page 18-19 and 24-26



## TOOLS FOR GTC MACHINING

---

- // maximum metal removal rate with highest process reliability
- // high manufacturing depths and utilisation of entire cutting edge length
- // adapted geometry and coating for highest process parameters

# ISO code

<b>P</b>	Steel, high-alloyed steel
<b>M</b>	Stainless steel
<b>K</b>	Grey cast iron, spheroidal graphite iron and malleable cast iron
<b>N</b>	Aluminium and other non-ferrous metals
<b>S</b>	Special, super and titanium-alloys
<b>H</b>	Hardened steel and chilled cast iron

On the programme pages you will find for every tool recommendations regarding suitability for the application groups and details of max. tensile strength and hardness.

- optimal suitability
- limited suitability

# Coatings

**P** AlCrN

**F** FIRE/nano FIRE





















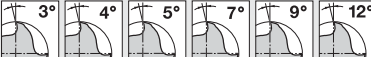

**R** Raptor

**Y** Signum

**A** TiAlN Super A

**Z** Zenit

# Pictograms

Tool material	<b>VHM</b>
	Solid carbide finest grain (carbide-UF)
Shank form	 HA HB
	to DIN 6535
Standard	 DIN 6527L
	to DIN
	 WN
	to Gühring standard
Type	<b>N</b> <b>NH</b>
Applications	 Slotting  Roughing  Ramping  Helix  Finishing  Copying
Length	 long (DIN)  medium length (DIN)
Number of cutting edges	 3  4  6
	Number of major cutting edges
Helix angle	
	Size of helix angle / number of different helix angles
Rake angle	
	Rake angle of circumference cutting edges
Cutting edge form	 45°  R±0,02  R±0,05
	Corner chamfer Radius with tolerance
Hardness	 48 HRC  55 HRC
	Workable material hardness in HRC
Feed	 for lateral feed and oblique plunging  for lateral feed, oblique plunging and drilling



**i**machining®

RF 100 Speed, article no. 6960 20.000 mm  
**RF 100 Speed in application //**

**Application:**

HPC roughing; dry machining  
in 42CrMo4 (1.7225 with 900 N/mm<sup>2</sup>)  
in HPC clamping chuck with PinLock pull-out safety

**Cutting parameters:**

$a_p$ : 60 mm       $a_e$ : up to 1 mm  
 $v_c$ : 270 m/min    S: 4300 min<sup>-1</sup>  
 $f_z$ : up to 0.21 mm     $v_f$ : up to 3715 mm/min

**Metal removal rate Q = 222 cm<sup>3</sup>/min**  
**Tool life above 278 min. for**  
**roughing operations!**



P	M	K	N	S	H	Tool illustration	Z	Hardness	Length	Helix angle °	Tool material	Surface	d1/mm	Article no.	Page
Ratio end mills RF 100 Speed M															
•	•						4			48°	VHM	A	3.000 - 20.000	6765	8
•	•						4			48°	VHM	A	3.000 - 20.000	6760	8
•	•						4			48°	VHM	A	3.000 - 20.000	6766	9
•	•						4			48°	VHM	A	3.000 - 20.000	6761	9
Ratio end mills RF 100 Speed P															
•	•				○		NEW	48 HRC		48°	VHM	A	6.000 - 25.000	6958	10
•	•				○		NEW	48 HRC		48°	VHM	A	6.000 - 25.000	6959	10
•	•				○		NEW	48 HRC		48°	VHM	A	6.000 - 25.000	6960	11
•	•				○		NEW	48 HRC		48°	VHM	A	6.000 - 25.000	6961	11
Ratio end mills RF 100 iMill															
•	○				•		NEW			38°/40°	VHM	P	3.000 - 20.000	6962	12
•	○				•		NEW			38°/40°	VHM	P	3.000 - 20.000	6963	12
○	•				•		NEW			38°/40°	VHM	Y	3.000 - 20.000	6964	14
○	•				•		NEW			38°/40°	VHM	Y	3.000 - 20.000	6965	14
Standard Ratio end mills RF 100 U															
•	•				○			48 HRC		35°/38°	VHM	F	6.000 - 25.000	3872	16
•	•				○			48 HRC		35°/38°	VHM	F	6.000 - 25.000	3873	16
•	•				○			48 HRC	3xD	35°/38°	VHM	F	6.000 - 20.000	3839	17
•	•				○			48 HRC	3xD	35°/38°	VHM	F	6.000 - 20.000	3871	17
•	○				○			48 HRC		35°/38°	VHM	R	6.000 - 20.000	6726	18
Multi-tooth end mills GH 100 U															
•	•				○		NEW	55 HRC		45°	VHM	R	6.000 - 20.000	6969	19
Ratio end mills RF 100 Ti															
•	•				○			48 HRC		35°/38°	VHM	A	6.000 - 25.000	3498	20
•	•				○			48 HRC		35°/38°	VHM	A	6.000 - 25.000	3499	20



P	M	K	N	S	H	Tool illustration	Z	Hardness	Length	Helix angle °	Tool material	Surface	d1/mm	Article no.	Page
Ratio end mills RF 100 Ti															
•	•	•	•	•			NEW	48 HRC	4	35° 38°	VHM	Z	6.000 - 25.000	6966	22
•	•	•	•	•			NEW	48 HRC	4	35° 38°	VHM	Z	6.000 - 25.000	6967	22
Standard Ratio end mills RF 100 U (3-fluted)															
•	•	•	•	•				48 HRC	3	41° 43° 45°	VHM	R	3.000 - 20.000	6728	24
Ratio end mills RF 100 F															
•	•	•	•	•	○		NEW	48 HRC	4	40° 42°	VHM	R	4.000 - 20.000	6968	25
Ratio end mills Superfinish RF 100 SF															
•	•	•	•	•	○			48 HRC	6	44° 45° 46°	VHM	R	8.000 - 20.000	6727	26
•	•	•	•	•	○			48 HRC	6	44° 45° 46°	VHM	F	8.000 - 25.000	3631	27
•	•	•	•	•	○			48 HRC	6	44° 45° 46°	VHM	F	8.000 - 25.000	3632	27
•	•	•	•	•	○			48 HRC	5	45°	VHM	F	4.000 - 25.000	6709	28
•	•	•	•	•	○			48 HRC	5	45°	VHM	F	4.000 - 25.000	6710	28
•	•	•	•	•	○			48 HRC	5	3xD 45°	VHM	F	4.000 - 20.000	3897	29
•	•	•	•	•	○			48 HRC	5	3xD 45°	VHM	F	4.000 - 20.000	3898	29

Ratio end mills RF 100 Speed M

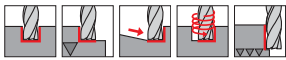

**P** • **GÜHRING NAVIGATOR**  
**M** • Cutting data page 34  
**K**  
**N**  
**S** •  
**H**

- RF 100 Speed M
- roughing operations of up to max. 0.8xD depth
- re-inforced core from Ø 6 mm
- centre cutting

Tool material	Solid carbide	
Surface	<b>A</b>	<b>A</b>
Type	NH	NH
Shank form	HA	HB

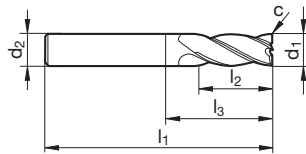

Article no. **6765** **6760**  
 Discount group **106** **106**

d1 h10	d2 h6	l1	l2	l3	c	Z	Code no.	Availability
mm	mm	mm	mm	mm	mm x 45°			
3.000	6.000	57.000	8.000	10.900	0.045	4	3.000	• •
4.000	6.000	57.000	11.000	13.900	0.060	4	4.000	• •
5.000	6.000	57.000	13.000	15.900	0.075	4	5.000	• •
6.000	6.000	57.000	15.000	21.000	0.090	4	6.000	• •
8.000	8.000	63.000	20.000	27.000	0.120	4	8.000	• •
10.000	10.000	72.000	24.000	32.000	0.150	4	10.000	• •
12.000	12.000	83.000	28.000	38.000	0.180	4	12.000	• •
16.000	16.000	92.000	36.000	44.000	0.240	4	16.000	• •
20.000	20.000	104.000	45.000	54.000	0.300	4	20.000	• •

ISO	Hardness	vc	fz (mm/z) / Ø							vc	fz (mm/z) / Ø						
			3	6	8	10	12	16	20		3	6	8	10	12	16	20
<b>P</b>	≤ 850 N/mm <sup>2</sup>	<b>340</b>	0,036	0,072	0,096	0,138	0,17	0,22	0,28	<b>360</b>	0,017	0,034	0,046	0,066	0,08	0,11	0,13
	≥ 850 N/mm <sup>2</sup>	<b>250</b>	0,031	0,062	0,083	0,115	0,14	0,18	0,23	<b>270</b>	0,015	0,030	0,040	0,055	0,07	0,09	0,11
<b>M</b>	≤ 750 N/mm <sup>2</sup>	<b>220</b>	0,031	0,062	0,083	0,115	0,14	0,18	0,23	<b>240</b>	0,015	0,030	0,040	0,055	0,07	0,09	0,11
	≥ 750 N/mm <sup>2</sup>	<b>110</b>	0,024	0,048	0,064	0,092	0,11	0,15	0,18	<b>120</b>	0,011	0,021	0,028	0,040	0,05	0,06	0,08
<b>S</b>	Ni-based	<b>60</b>	0,019	0,039	0,052	0,074	0,09	0,12	0,15	<b>60</b>	0,008	0,017	0,022	0,032	0,04	0,05	0,06
	Ti-based	<b>110</b>	0,028	0,055	0,074	0,104	0,12	0,17	0,21	<b>120</b>	0,013	0,026	0,035	0,050	0,06	0,08	0,10





Ratio end mills RF 100 Speed M

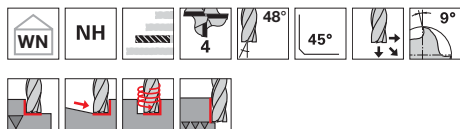

**P** • **GÜHRING NAVIGATOR**  
**M** • Cutting data page 34  
**K**  
**N**  
**S** •  
**H**

- RF 100 Speed M
- with chip breaker
- re-inforced core from Ø 6 mm
- centre cutting

Tool material	Solid carbide	
Surface	A	A
Type	NH	NH
Shank form	HA	HB

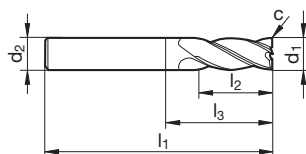

Article no.	<b>6766</b>	<b>6761</b>
Discount group	<b>106</b>	<b>106</b>

d1 h10	d2 h6	l1	l2	l3	c	Z	Code no.	Availability
mm	mm	mm	mm	mm	mm x 45°			
3.000	6.000	57.000	12.000	14.900	0.045	4	3.000	● ●
4.000	6.000	65.000	16.000	18.900	0.060	4	4.000	● ●
5.000	6.000	65.000	20.000	22.900	0.075	4	5.000	● ●
6.000	6.000	65.000	24.000	29.000	0.090	4	6.000	● ●
8.000	8.000	75.000	32.000	39.000	0.120	4	8.000	● ●
10.000	10.000	90.000	40.000	50.000	0.150	4	10.000	● ●
12.000	12.000	100.000	46.000	55.000	0.180	4	12.000	● ●
16.000	16.000	108.000	55.000	60.000	0.240	4	16.000	● ●
20.000	20.000	126.000	65.000	76.000	0.300	4	20.000	● ●

ISO	Hardness	vc	fz (mm/z) / Ø							vc	fz (mm/z) / Ø						
			3	6	8	10	12	16	20		3	6	8	10	12	16	20
P	≤ 850 N/mm <sup>2</sup>	<b>340</b>	0,036	0,072	0,096	0,138	0,17	0,22	0,28	<b>360</b>	0,017	0,034	0,046	0,066	0,08	0,11	0,13
	≥ 850 N/mm <sup>2</sup>	<b>250</b>	0,031	0,062	0,083	0,115	0,14	0,18	0,23	<b>270</b>	0,015	0,030	0,040	0,055	0,07	0,09	0,11
M	≤ 750 N/mm <sup>2</sup>	<b>220</b>	0,031	0,062	0,083	0,115	0,14	0,18	0,23	<b>240</b>	0,015	0,030	0,040	0,055	0,07	0,09	0,11
	≥ 750 N/mm <sup>2</sup>	<b>110</b>	0,024	0,048	0,064	0,092	0,11	0,15	0,18	<b>120</b>	0,011	0,021	0,028	0,040	0,05	0,06	0,08
S	Ni-based	<b>60</b>	0,019	0,039	0,052	0,074	0,09	0,12	0,15	<b>60</b>	0,008	0,017	0,022	0,032	0,04	0,05	0,06
	Ti-based	<b>110</b>	0,028	0,055	0,074	0,104	0,12	0,17	0,21	<b>120</b>	0,013	0,026	0,035	0,050	0,06	0,08	0,10

Ratio end mills RF 100 Speed P

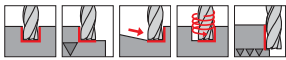

P	•
M	
K	•
N	
S	
H	○

**GÜHRING NAVIGATOR**

Cutting data page 34

- RF 100 Speed P
- with chip breaker
- roughing operations of up to max. 0.8xD depth
- re-inforced core from Ø 6 mm
- centre cutting

Tool material	Solid carbide	
Surface	A	A
Type	NH	NH
Shank form	HA	HB

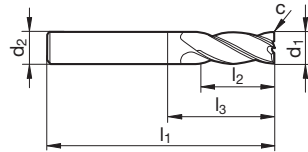

Article no.	6958	6959
Discount group	106	106

d1 h10	d2 h6	l1	l2	l3	c	Z	Code no.	Availability
mm	mm	mm	mm	mm	mm x 45°			
6.000	6.000	57.000	15.000	21.000	0.120	4	6.000	● ●
8.000	8.000	63.000	20.000	27.000	0.160	4	8.000	● ●
10.000	10.000	72.000	24.000	32.000	0.200	4	10.000	● ●
12.000	12.000	83.000	28.000	38.000	0.240	4	12.000	● ●
16.000	16.000	92.000	36.000	44.000	0.320	4	16.000	● ●
20.000	20.000	104.000	45.000	54.000	0.400	4	20.000	● ●
25.000	25.000	121.000	55.000	65.000	0.500	4	25.000	● ●

ISO	Hardness	vc	fz (mm/z) / Ø							vc	fz (mm/z) / Ø						
			3	6	8	10	12	16	20		3	6	8	10	12	16	20
P	≤ 850 N/mm <sup>2</sup>	340	0,036	0,072	0,096	0,138	0,17	0,22	0,28	360	0,017	0,034	0,046	0,066	0,08	0,11	0,13
	≥ 850 N/mm <sup>2</sup>	250	0,031	0,062	0,083	0,115	0,14	0,18	0,23	270	0,015	0,030	0,040	0,055	0,07	0,09	0,11
K	≤ 240 HB	300	0,038	0,076	0,101	0,150	0,18	0,24	0,30	320	0,018	0,036	0,048	0,072	0,09	0,11	0,14
	≥ 240 HB	260	0,035	0,069	0,092	0,127	0,15	0,20	0,25	280	0,017	0,033	0,044	0,061	0,07	0,10	0,12



Ratio end mills RF 100 Speed P

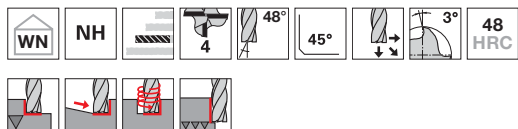

P	•
M	
K	•
N	
S	
H	○

**GÜHRING** NAVIGATOR

Cutting data page 34

- RF 100 Speed P
- with chip breaker
- re-inforced core from Ø 6 mm
- centre cutting

Tool material	Solid carbide	
Surface	A	A
Type	NH	NH
Shank form	HA	HB

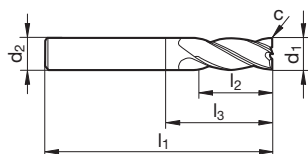

Article no.	6960	6961
Discount group	106	106

d1 h10	d2 h6	l1	l2	l3	c	Z	Code no.	Availability
mm	mm	mm	mm	mm	mm x 45°			
6.000	6.000	65.000	24.000	29.000	0.120	4	6.000	● ●
8.000	8.000	75.000	32.000	39.000	0.160	4	8.000	● ●
10.000	10.000	90.000	40.000	50.000	0.200	4	10.000	● ●
12.000	12.000	100.000	46.000	55.000	0.240	4	12.000	● ●
16.000	16.000	108.000	55.000	60.000	0.320	4	16.000	● ●
20.000	20.000	126.000	65.000	76.000	0.400	4	20.000	● ●
25.000	25.000	150.000	85.000	94.000	0.500	4	25.000	● ●

ISO	Hardness	vc	fz (mm/z) / Ø							vc	fz (mm/z) / Ø						
			3	6	8	10	12	16	20		3	6	8	10	12	16	20
P	≤ 850 N/mm <sup>2</sup>	340	0,036	0,072	0,096	0,138	0,17	0,22	0,28	360	0,017	0,034	0,046	0,066	0,08	0,11	0,13
	≥ 850 N/mm <sup>2</sup>	250	0,031	0,062	0,083	0,115	0,14	0,18	0,23	270	0,015	0,030	0,040	0,055	0,07	0,09	0,11
K	≤ 240 HB	300	0,038	0,076	0,101	0,150	0,18	0,24	0,30	320	0,018	0,036	0,048	0,072	0,09	0,11	0,14
	≥ 240 HB	260	0,035	0,069	0,092	0,127	0,15	0,20	0,25	280	0,017	0,033	0,044	0,061	0,07	0,10	0,12

Ratio end mills RF 100 iMill

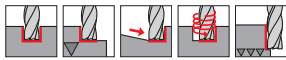

P	•
M	○
K	
N	•
S	•
H	

**GÜHRING NAVIGATOR**

Cutting data page 34

- neck clearance
- centre cutting

Tool material	Solid carbide	
Surface	P	P
Type	N	N
Shank form	HA	HB

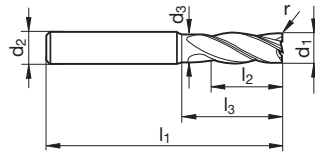



Article no.	6962	6963
Discount group	106	106

d1 e8	d2 h6	d3	l1	l2	l3	r	Z	Code no.	Availability
mm	mm	mm	mm	mm	mm	mm			
3.000	6.000	2.800	57.000	8.000	15.000	0.200	4	3.002	•
3.000	6.000	2.800	57.000	8.000	15.000	0.500	4	3.005	•
4.000	6.000	3.800	57.000	11.000	18.000	0.200	4	4.002	•
4.000	6.000	3.800	57.000	11.000	18.000	0.500	4	4.005	•
4.000	6.000	3.800	57.000	11.000	18.000	1.000	4	4.010	•
5.000	6.000	4.800	57.000	13.000	18.000	0.200	4	5.002	•
5.000	6.000	4.800	57.000	13.000	18.000	0.500	4	5.005	•
5.000	6.000	4.800	57.000	13.000	18.000	1.000	4	5.010	•
6.000	6.000	5.700	57.000	13.000	20.000	0.200	4	6.002	•
6.000	6.000	5.700	57.000	13.000	20.000	0.500	4	6.005	•
6.000	6.000	5.700	57.000	13.000	20.000	1.000	4	6.010	•
6.000	6.000	5.700	57.000	13.000	20.000	1.500	4	6.015	•
8.000	8.000	7.700	63.000	19.000	26.000	0.300	4	8.003	•
8.000	8.000	7.700	63.000	19.000	26.000	0.500	4	8.005	•
8.000	8.000	7.700	63.000	19.000	26.000	1.000	4	8.010	•
8.000	8.000	7.700	63.000	19.000	26.000	1.500	4	8.015	•
8.000	8.000	7.700	63.000	19.000	26.000	2.000	4	8.020	•
10.000	10.000	9.500	72.000	22.000	30.000	0.300	4	10.003	•
10.000	10.000	9.500	72.000	22.000	30.000	0.500	4	10.005	•
10.000	10.000	9.500	72.000	22.000	30.000	1.000	4	10.010	•
10.000	10.000	9.500	72.000	22.000	30.000	1.500	4	10.015	•
10.000	10.000	9.500	72.000	22.000	30.000	2.000	4	10.020	•
10.000	10.000	9.500	72.000	22.000	30.000	2.500	4	10.025	•
12.000	12.000	11.500	83.000	26.000	36.000	0.300	4	12.003	•
12.000	12.000	11.500	83.000	26.000	36.000	0.500	4	12.005	•
12.000	12.000	11.500	83.000	26.000	36.000	1.000	4	12.010	•
12.000	12.000	11.500	83.000	26.000	36.000	1.500	4	12.015	•
12.000	12.000	11.500	83.000	26.000	36.000	2.000	4	12.020	•
12.000	12.000	11.500	83.000	26.000	36.000	2.500	4	12.025	•
12.000	12.000	11.500	83.000	26.000	36.000	3.000	4	12.030	•



									Article no.	6962	6963	
									Discount group		106	106
d1 e8	d2 h6	d3	l1	l2	l3	r	Z	Code no.	Availability			
mm	mm	mm	mm	mm	mm	mm						
16.000	16.000	15.500	92.000	32.000	42.000	0.500	4	16.005	●	●		
16.000	16.000	15.500	92.000	32.000	42.000	1.000	4	16.010	●	●		
16.000	16.000	15.500	92.000	32.000	42.000	1.500	4	16.015	●	●		
16.000	16.000	15.500	92.000	32.000	42.000	2.000	4	16.020	●	●		
16.000	16.000	15.500	92.000	32.000	42.000	2.500	4	16.025	●	●		
16.000	16.000	15.500	92.000	32.000	42.000	3.000	4	16.030	●	●		
16.000	16.000	15.500	92.000	32.000	42.000	4.000	4	16.040	●	●		
20.000	20.000	19.500	104.000	38.000	52.000	0.500	4	20.005	●	●		
20.000	20.000	19.500	104.000	38.000	52.000	1.000	4	20.010	●	●		
20.000	20.000	19.500	104.000	38.000	52.000	1.500	4	20.015	●	●		
20.000	20.000	19.500	104.000	38.000	52.000	2.000	4	20.020	●	●		
20.000	20.000	19.500	104.000	38.000	52.000	2.500	4	20.025	●	●		
20.000	20.000	19.500	104.000	38.000	52.000	3.000	4	20.030	●	●		
20.000	20.000	19.500	104.000	38.000	52.000	4.000	4	20.040	●	●		

ISO	Hardness	vc	fz (mm/z) / Ø							vc	fz (mm/z) / Ø						
			3	6	8	10	12	16	20		3	6	8	10	12	16	20
			ap = 1,0 x D				ae = 1,0 x D				ap = 1,0 x D				ae max = 0,75 x D		
P	≤ 850 N/mm <sup>2</sup>	180	0,016	0,031	0,042	0,060	0,07	0,10	0,12	210	0,018	0,036	0,048	0,069	0,08	0,11	0,14
	≥ 850 N/mm <sup>2</sup>	135	0,014	0,027	0,036	0,050	0,06	0,08	0,10	160	0,016	0,031	0,041	0,058	0,07	0,09	0,12
M	≤ 750 N/mm <sup>2</sup>	120	0,014	0,027	0,036	0,050	0,06	0,08	0,10	140	0,016	0,031	0,041	0,058	0,07	0,09	0,12
	≥ 750 N/mm <sup>2</sup>	60	0,011	0,021	0,028	0,040	0,05	0,06	0,08	80	0,013	0,025	0,034	0,048	0,06	0,08	0,10
S	Ni-based	30	0,008	0,017	0,022	0,032	0,04	0,05	0,06	40	0,010	0,020	0,027	0,038	0,05	0,06	0,08
	Ti-based	60	0,012	0,024	0,032	0,045	0,05	0,07	0,09	80	0,014	0,029	0,038	0,054	0,06	0,09	0,11
N	≤ 5% Si	500	0,020	0,039	0,052	0,080	0,10	0,13	0,16	600	0,022	0,045	0,060	0,092	0,11	0,15	0,18
	≥ 5% Si	230	0,017	0,033	0,044	0,060	0,07	0,10	0,12	300	0,019	0,038	0,051	0,069	0,08	0,11	0,14

Ratio end mills RF 100 iMill

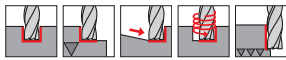

P	○
M	●
K	
N	●
S	●
H	

**GÜHRING NAVIGATOR**

Cutting data page 34

- neck clearance
- centre cutting

Tool material	Solid carbide	
Surface	Y	Y
Type	N	N
Shank form	HA	HB

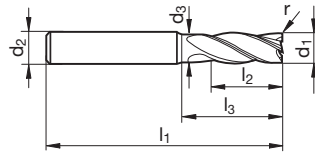



Article no.	6964	6965
Discount group	106	106

d1 e8	d2 h6	d3	l1	l2	l3	r	Z	Code no.	Availability
mm	mm	mm	mm	mm	mm	mm			
3.000	6.000	2.800	57.000	8.000	15.000	0.200	4	3.002	● ●
3.000	6.000	2.800	57.000	8.000	15.000	0.500	4	3.005	● ●
4.000	6.000	3.800	57.000	11.000	18.000	0.200	4	4.002	● ●
4.000	6.000	3.800	57.000	11.000	18.000	0.500	4	4.005	● ●
4.000	6.000	3.800	57.000	11.000	18.000	1.000	4	4.010	● ●
5.000	6.000	4.800	57.000	13.000	18.000	0.200	4	5.002	● ●
5.000	6.000	4.800	57.000	13.000	18.000	0.500	4	5.005	● ●
5.000	6.000	4.800	57.000	13.000	18.000	1.000	4	5.010	● ●
6.000	6.000	5.700	57.000	13.000	20.000	0.200	4	6.002	● ●
6.000	6.000	5.700	57.000	13.000	20.000	0.500	4	6.005	● ●
6.000	6.000	5.700	57.000	13.000	20.000	1.000	4	6.010	● ●
6.000	6.000	5.700	57.000	13.000	20.000	1.500	4	6.015	● ●
8.000	8.000	7.700	63.000	19.000	26.000	0.300	4	8.003	● ●
8.000	8.000	7.700	63.000	19.000	26.000	0.500	4	8.005	● ●
8.000	8.000	7.700	63.000	19.000	26.000	1.000	4	8.010	● ●
8.000	8.000	7.700	63.000	19.000	26.000	1.500	4	8.015	● ●
8.000	8.000	7.700	63.000	19.000	26.000	2.000	4	8.020	● ●
10.000	10.000	9.500	72.000	22.000	30.000	0.300	4	10.003	● ●
10.000	10.000	9.500	72.000	22.000	30.000	0.500	4	10.005	● ●
10.000	10.000	9.500	72.000	22.000	30.000	1.000	4	10.010	● ●
10.000	10.000	9.500	72.000	22.000	30.000	1.500	4	10.015	● ●
10.000	10.000	9.500	72.000	22.000	30.000	2.000	4	10.020	● ●
10.000	10.000	9.500	72.000	22.000	30.000	2.500	4	10.025	● ●
12.000	12.000	11.500	83.000	26.000	36.000	0.300	4	12.003	● ●
12.000	12.000	11.500	83.000	26.000	36.000	0.500	4	12.005	● ●
12.000	12.000	11.500	83.000	26.000	36.000	1.000	4	12.010	● ●
12.000	12.000	11.500	83.000	26.000	36.000	1.500	4	12.015	● ●
12.000	12.000	11.500	83.000	26.000	36.000	2.000	4	12.020	● ●
12.000	12.000	11.500	83.000	26.000	36.000	2.500	4	12.025	● ●
12.000	12.000	11.500	83.000	26.000	36.000	3.000	4	12.030	● ●



									Article no.	6964	6965	
									Discount group		106	106
d1 e8	d2 h6	d3	l1	l2	l3	r	Z	Code no.	Availability			
mm	mm	mm	mm	mm	mm	mm						
16.000	16.000	15.500	92.000	32.000	42.000	0.500	4	16.005	●	●		
16.000	16.000	15.500	92.000	32.000	42.000	1.000	4	16.010	●	●		
16.000	16.000	15.500	92.000	32.000	42.000	1.500	4	16.015	●	●		
16.000	16.000	15.500	92.000	32.000	42.000	2.000	4	16.020	●	●		
16.000	16.000	15.500	92.000	32.000	42.000	2.500	4	16.025	●	●		
16.000	16.000	15.500	92.000	32.000	42.000	3.000	4	16.030	●	●		
16.000	16.000	15.500	92.000	32.000	42.000	4.000	4	16.040	●	●		
20.000	20.000	19.500	104.000	38.000	52.000	0.500	4	20.005	●	●		
20.000	20.000	19.500	104.000	38.000	52.000	1.000	4	20.010	●	●		
20.000	20.000	19.500	104.000	38.000	52.000	1.500	4	20.015	●	●		
20.000	20.000	19.500	104.000	38.000	52.000	2.000	4	20.020	●	●		
20.000	20.000	19.500	104.000	38.000	52.000	2.500	4	20.025	●	●		
20.000	20.000	19.500	104.000	38.000	52.000	3.000	4	20.030	●	●		
20.000	20.000	19.500	104.000	38.000	52.000	4.000	4	20.040	●	●		

ISO	Hardness	vc	fz (mm/z) / Ø							vc	fz (mm/z) / Ø						
			3	6	8	10	12	16	20		3	6	8	10	12	16	20
			ap = 1,0 x D				ae = 1,0 x D				ap = 1,0 x D				ae max = 0,75 x D		
P	≤ 850 N/mm <sup>2</sup>	180	0,016	0,031	0,042	0,060	0,07	0,10	0,12	210	0,018	0,036	0,048	0,069	0,08	0,11	0,14
	≥ 850 N/mm <sup>2</sup>	135	0,014	0,027	0,036	0,050	0,06	0,08	0,10	160	0,016	0,031	0,041	0,058	0,07	0,09	0,12
M	≤ 750 N/mm <sup>2</sup>	120	0,014	0,027	0,036	0,050	0,06	0,08	0,10	140	0,016	0,031	0,041	0,058	0,07	0,09	0,12
	≥ 750 N/mm <sup>2</sup>	60	0,011	0,021	0,028	0,040	0,05	0,06	0,08	80	0,013	0,025	0,034	0,048	0,06	0,08	0,10
S	Ni-based	30	0,008	0,017	0,022	0,032	0,04	0,05	0,06	40	0,010	0,020	0,027	0,038	0,05	0,06	0,08
	Ti-based	60	0,012	0,024	0,032	0,045	0,05	0,07	0,09	80	0,014	0,029	0,038	0,054	0,06	0,09	0,11
N	≤ 5% Si	500	0,020	0,039	0,052	0,080	0,10	0,13	0,16	600	0,022	0,045	0,060	0,092	0,11	0,15	0,18
	≥ 5% Si	230	0,017	0,033	0,044	0,060	0,07	0,10	0,12	300	0,019	0,038	0,051	0,069	0,08	0,11	0,14

Standard Ratio end mills RF 100 U

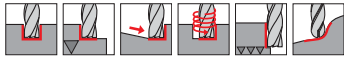
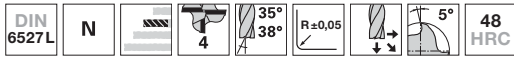

P	•
M	
K	•
N	
S	
H	○

**GÜHRING NAVIGATOR**  
Cutting data page 34

- re-inforced core
- neck clearance
- centre cutting

Tool material	Solid carbide	
Surface	F	F
Type	N	N
Shank form	HA	HB

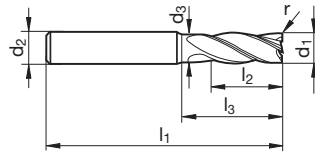

Article no.	3872	3873
Discount group	106	106

d1 h10	d2 h6	d3	l1	l2	l3	r	Z	Code no.	Availability
mm	mm	mm	mm	mm	mm	mm			
6.000	6.000	5.700	57.000	13.000	20.000	0.500	4	6.005	• •
6.000	6.000	5.700	57.000	13.000	20.000	1.000	4	6.010	• •
6.000	6.000	5.700	57.000	13.000	20.000	2.000	4	6.020	• •
8.000	8.000	7.700	63.000	19.000	26.000	0.500	4	8.005	• •
8.000	8.000	7.700	63.000	19.000	26.000	1.000	4	8.010	• •
8.000	8.000	7.700	63.000	19.000	26.000	2.000	4	8.020	• •
10.000	10.000	9.500	72.000	22.000	30.000	0.500	4	10.005	• •
10.000	10.000	9.500	72.000	22.000	30.000	1.000	4	10.010	• •
10.000	10.000	9.500	72.000	22.000	30.000	2.000	4	10.020	• •
12.000	12.000	11.500	83.000	26.000	36.000	0.500	4	12.005	• •
12.000	12.000	11.500	83.000	26.000	36.000	1.000	4	12.010	• •
12.000	12.000	11.500	83.000	26.000	36.000	2.000	4	12.020	• •
16.000	16.000	15.500	92.000	32.000	42.000	0.500	4	16.005	• •
16.000	16.000	15.500	92.000	32.000	42.000	1.000	4	16.010	• •
16.000	16.000	15.500	92.000	32.000	42.000	2.000	4	16.020	• •
16.000	16.000	15.500	92.000	32.000	42.000	3.000	4	16.030	• •
20.000	20.000	19.500	104.000	38.000	52.000	0.500	4	20.005	• •
20.000	20.000	19.500	104.000	38.000	52.000	1.000	4	20.010	• •
20.000	20.000	19.500	104.000	38.000	52.000	2.000	4	20.020	• •
20.000	20.000	19.500	104.000	38.000	52.000	3.000	4	20.030	• •
25.000	25.000	24.000	121.000	45.000	63.000	2.000	4	25.020	• •
25.000	25.000	24.000	121.000	45.000	63.000	3.000	4	25.030	• •

ISO	Hardness	vc	fz (mm/z) / Ø							vc	fz (mm/z) / Ø							
			3	6	8	10	12	16	20		3	6	8	10	12	16	20	
P	≤ 850 N/mm <sup>2</sup>	180	0,016	0,031	0,042	0,060	0,07	0,10	0,12		305	0,025	0,050	0,067	0,096	0,12	0,15	0,19
	≥ 850 N/mm <sup>2</sup>	135	0,014	0,027	0,036	0,050	0,06	0,08	0,10		230	0,022	0,043	0,058	0,080	0,10	0,13	0,16
K	≤ 240 HB	160	0,017	0,033	0,044	0,065	0,08	0,10	0,13		270	0,026	0,053	0,070	0,104	0,12	0,17	0,21
	≥ 240 HB	140	0,015	0,030	0,040	0,055	0,07	0,09	0,11		240	0,024	0,048	0,064	0,088	0,11	0,14	0,18





Standard Ratio end mills RF 100 U

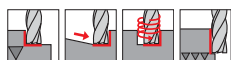

P	•
M	
K	•
N	
S	
H	○

**GÜHRING** NAVIGATOR

Cutting data page 34

- neck clearance
- centre cutting

Tool material	Solid carbide	
Surface	F	F
Type	N	N
Shank form	HA	HB

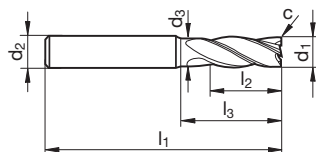

Article no.	<b>3839</b>	<b>3871</b>
Discount group	<b>106</b>	<b>106</b>

d1 h10	d2 h6	d3	l1	l2	l3	c	Z	Code no.	Availability
mm	mm	mm	mm	mm	mm	mm x 45°			
6.000	6.000	5.700	65.000	18.000	28.000	0.150	4	6.000	● ●
8.000	8.000	7.700	75.000	24.000	38.000	0.150	4	8.000	● ●
10.000	10.000	9.500	80.000	30.000	38.000	0.200	4	10.000	● ●
12.000	12.000	11.500	93.000	36.000	46.000	0.200	4	12.000	● ●
16.000	16.000	15.500	108.000	48.000	58.000	0.350	4	16.000	● ●
20.000	20.000	19.500	126.000	60.000	74.000	0.450	4	20.000	● ●

ISO	Hardness	vc	fz (mm/z) / Ø							vc	fz (mm/z) / Ø						
			3	6	8	10	12	16	20		3	6	8	10	12	16	20
P	≤ 850 N/mm <sup>2</sup>	<b>340</b>	0,036	0,072	0,096	0,138	0,17	0,22	0,28	<b>360</b>	0,017	0,034	0,046	0,066	0,08	0,11	0,13
	≥ 850 N/mm <sup>2</sup>	<b>250</b>	0,031	0,062	0,083	0,115	0,14	0,18	0,23		<b>270</b>	0,015	0,030	0,040	0,055	0,07	0,09
K	≤ 240 HB	<b>300</b>	0,038	0,076	0,101	0,150	0,18	0,24	0,30	<b>320</b>	0,018	0,036	0,048	0,072	0,09	0,11	0,14
	≥ 240 HB	<b>260</b>	0,035	0,069	0,092	0,127	0,15	0,20	0,25		<b>280</b>	0,017	0,033	0,044	0,061	0,07	0,10

Standard Ratio end mills RF 100 U

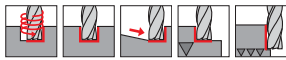

P	•
M	○
K	
N	
S	•
H	○

**GÜHRING** NAVIGATOR

Cutting data page 34

- Raptor coating
- neck clearance
- centre cutting

Tool material **Solid carbide**

Surface **R**

Type **N**

Shank form **HB**

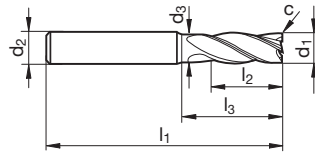

Article no. **6726**

Discount group **106**

d1 h10	d2 h6	d3	l1	l2	l3	c	Z	Code no.	Availability
mm	mm	mm	mm	mm	mm	mm x 45°			
6.000	6.000	5.700	57.000	13.000	20.000	0.150	4	6.000	•
8.000	8.000	7.700	63.000	19.000	26.000	0.150	4	8.000	•
10.000	10.000	9.500	72.000	22.000	30.000	0.200	4	10.000	•
12.000	12.000	11.500	83.000	26.000	36.000	0.200	4	12.000	•
16.000	16.000	15.500	92.000	32.000	42.000	0.350	4	16.000	•
20.000	20.000	19.500	104.000	38.000	52.000	0.450	4	20.000	•

ISO	Hardness	vc	fz (mm/z) / Ø							vc	fz (mm/z) / Ø						
			3	6	8	10	12	16	20		3	6	8	10	12	16	20
P	≤ 850 N/mm <sup>2</sup>	<b>340</b>	0,036	0,072	0,096	0,138	0,17	0,22	0,28	<b>360</b>	0,017	0,034	0,046	0,066	0,08	0,11	0,13
	≥ 850 N/mm <sup>2</sup>	<b>250</b>	0,031	0,062	0,083	0,115	0,14	0,18	0,23		<b>270</b>	0,015	0,030	0,040	0,055	0,07	0,09
M	≤ 750 N/mm <sup>2</sup>	<b>220</b>	0,031	0,062	0,083	0,115	0,14	0,18	0,23	<b>240</b>	0,015	0,030	0,040	0,055	0,07	0,09	0,11
	≥ 750 N/mm <sup>2</sup>	<b>110</b>	0,024	0,048	0,064	0,092	0,11	0,15	0,18		<b>120</b>	0,011	0,021	0,028	0,040	0,05	0,06
S	Ni-based	<b>60</b>	0,019	0,039	0,052	0,074	0,09	0,12	0,15	<b>60</b>	0,008	0,017	0,022	0,032	0,04	0,05	0,06
	Ti-based	<b>110</b>	0,028	0,055	0,074	0,104	0,12	0,17	0,21		<b>120</b>	0,013	0,026	0,035	0,050	0,06	0,08



Multi-tooth end mills GH 100 U

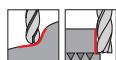

P	•
M	•
K	
N	•
S	•
H	○

**GÜHRING**NAVIGATOR

Cutting data page 34

- Raptor coating
- neck clearance
- centre cutting

Tool material	<b>Solid carbide</b>
Surface	<b>R</b>
Type	NH
Shank form	HB

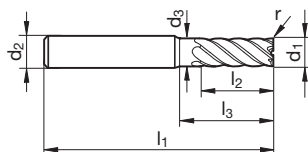

Article no. **6969**

Discount group **106**

d1 h10	d2 h6	d3	l1	l2	l3	r	Z	Code no.	Availability
mm	mm	mm	mm	mm	mm	mm			
6.000	6.000	5.700	57.000	13.000	20.000	0.500	6	6.005	•
6.000	6.000	5.700	57.000	13.000	20.000	1.000	6	6.010	•
8.000	8.000	7.700	63.000	19.000	26.000	0.500	6	8.005	•
8.000	8.000	7.700	63.000	19.000	26.000	1.000	6	8.010	•
8.000	8.000	7.700	63.000	19.000	26.000	1.500	6	8.015	•
8.000	8.000	7.700	63.000	19.000	26.000	2.000	6	8.020	•
10.000	10.000	9.500	72.000	22.000	30.000	0.500	6	10.005	•
10.000	10.000	9.500	72.000	22.000	30.000	1.000	6	10.010	•
10.000	10.000	9.500	72.000	22.000	30.000	1.500	6	10.015	•
10.000	10.000	9.500	72.000	22.000	30.000	2.000	6	10.020	•
12.000	12.000	11.500	83.000	26.000	36.000	0.500	6	12.005	•
12.000	12.000	11.500	83.000	26.000	36.000	1.000	6	12.010	•
12.000	12.000	11.500	83.000	26.000	36.000	1.500	6	12.015	•
12.000	12.000	11.500	83.000	26.000	36.000	2.000	6	12.020	•
16.000	16.000	15.500	92.000	32.000	42.000	0.500	6	16.005	•
16.000	16.000	15.500	92.000	32.000	42.000	1.000	6	16.010	•
16.000	16.000	15.500	92.000	32.000	42.000	1.500	6	16.015	•
16.000	16.000	15.500	92.000	32.000	42.000	2.000	6	16.020	•
20.000	20.000	19.500	104.000	38.000	52.000	0.500	8	20.005	•
20.000	20.000	19.500	104.000	38.000	52.000	1.000	8	20.010	•
20.000	20.000	19.500	104.000	38.000	52.000	1.500	8	20.015	•
20.000	20.000	19.500	104.000	38.000	52.000	2.000	8	20.020	•

ISO	Hardness	vc	fz (mm/z) / Ø						vc	fz (mm/z) / Ø							
			3	6	8	10	12	16		20	3	6	8	10	12	16	20
P	≤ 850 N/mm <sup>2</sup>	<b>340</b>	0,036	0,072	0,096	0,138	0,17	0,22	0,28	<b>360</b>	0,017	0,034	0,046	0,066	0,08	0,11	0,13
	≥ 850 N/mm <sup>2</sup>		<b>250</b>	0,031	0,062	0,083	0,115	0,14	0,18		0,23	<b>270</b>	0,015	0,030	0,040	0,055	0,07
M	≤ 750 N/mm <sup>2</sup>	<b>220</b>	0,031	0,062	0,083	0,115	0,14	0,18	0,23	<b>240</b>	0,015	0,030	0,040	0,055	0,07	0,09	0,11
	≥ 750 N/mm <sup>2</sup>		<b>110</b>	0,024	0,048	0,064	0,092	0,11	0,15		0,18	<b>120</b>	0,011	0,021	0,028	0,040	0,05
S	Ni-based	<b>60</b>	0,019	0,039	0,052	0,074	0,09	0,12	0,15	<b>60</b>	0,008	0,017	0,022	0,032	0,04	0,05	0,06
	Ti-based		<b>110</b>	0,028	0,055	0,074	0,104	0,12	0,17		0,21	<b>120</b>	0,013	0,026	0,035	0,050	0,06
N	≤ 7 % Si	<b>900</b>	0,045	0,090	0,120	0,184	0,22	0,29	0,37	<b>1000</b>	0,021	0,043	0,057	0,088	0,11	0,14	0,18
	≥ 7 % Si		<b>430</b>	0,038	0,076	0,101	0,138	0,17	0,22		0,28	<b>460</b>	0,018	0,036	0,048	0,066	0,08

Ratio end mills RF 100 Ti

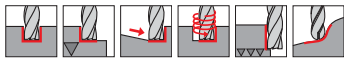

P	•
M	•
K	
N	
S	•
H	○

**GÜHRING NAVIGATOR**

Cutting data page 34

- re-inforced core
- neck clearance
- centre cutting

Tool material	Solid carbide	
Surface	A	A
Type	N	N
Shank form	HA	HB

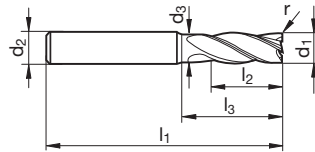



Article no. **3498** **3499**

Discount group **106** **106**

d1 h10	d2 h6	d3	l1	l2	l3	r	Z	Code no.	Availability
mm	mm	mm	mm	mm	mm	mm			
6.000	6.000	5.700	57.000	13.000	20.000	0.500	4	6.005	• •
6.000	6.000	5.700	57.000	13.000	20.000	0.800	4	6.008	• •
6.000	6.000	5.700	57.000	13.000	20.000	1.000	4	6.010	• •
6.000	6.000	5.700	57.000	13.000	20.000	1.500	4	6.015	• •
6.000	6.000	5.700	57.000	13.000	20.000	2.000	4	6.020	• •
8.000	8.000	7.700	63.000	19.000	26.000	0.500	4	8.005	• •
8.000	8.000	7.700	63.000	19.000	26.000	0.800	4	8.008	• •
8.000	8.000	7.700	63.000	19.000	26.000	1.000	4	8.010	• •
8.000	8.000	7.700	63.000	19.000	26.000	1.500	4	8.015	• •
8.000	8.000	7.700	63.000	19.000	26.000	2.000	4	8.020	• •
10.000	10.000	9.500	72.000	22.000	30.000	0.500	4	10.005	• •
10.000	10.000	9.500	72.000	22.000	30.000	0.800	4	10.008	• •
10.000	10.000	9.500	72.000	22.000	30.000	1.000	4	10.010	• •
10.000	10.000	9.500	72.000	22.000	30.000	1.500	4	10.015	• •
10.000	10.000	9.500	72.000	22.000	30.000	2.000	4	10.020	• •
12.000	12.000	11.500	83.000	26.000	36.000	0.500	4	12.005	• •
12.000	12.000	11.500	83.000	26.000	36.000	0.800	4	12.008	• •
12.000	12.000	11.500	83.000	26.000	36.000	1.000	4	12.010	• •
12.000	12.000	11.500	83.000	26.000	36.000	1.500	4	12.015	• •
12.000	12.000	11.500	83.000	26.000	36.000	2.000	4	12.020	• •
12.000	12.000	11.500	83.000	26.000	36.000	2.500	4	12.025	• •
12.000	12.000	11.500	83.000	26.000	36.000	3.000	4	12.030	• •
12.000	12.000	11.500	83.000	26.000	36.000	3.175	4	12.031	• •
12.000	12.000	11.500	83.000	26.000	36.000	4.000	4	12.040	• •
16.000	16.000	15.500	92.000	32.000	42.000	0.500	4	16.005	• •
16.000	16.000	15.500	92.000	32.000	42.000	0.800	4	16.008	• •
16.000	16.000	15.500	92.000	32.000	42.000	1.000	4	16.010	• •
16.000	16.000	15.500	92.000	32.000	42.000	1.500	4	16.015	• •
16.000	16.000	15.500	92.000	32.000	42.000	2.000	4	16.020	• •
16.000	16.000	15.500	92.000	32.000	42.000	2.500	4	16.025	• •



									Article no.	3498	3499
									Discount group	106	106
d1 h10	d2 h6	d3	l1	l2	l3	r	Z	Code no.	Availability		
mm	mm	mm	mm	mm	mm	mm					
16.000	16.000	15.500	92.000	32.000	42.000	3.000	4	16.030	●	●	
16.000	16.000	15.500	92.000	32.000	42.000	3.175	4	16.031	●	●	
16.000	16.000	15.500	92.000	32.000	42.000	4.000	4	16.040	●	●	
20.000	20.000	19.500	104.000	38.000	52.000	0.500	4	20.005	●	●	
20.000	20.000	19.500	104.000	38.000	52.000	1.000	4	20.010	●	●	
20.000	20.000	19.500	104.000	38.000	52.000	1.500	4	20.015	●	●	
20.000	20.000	19.500	104.000	38.000	52.000	2.000	4	20.020	●	●	
20.000	20.000	19.500	104.000	38.000	52.000	2.500	4	20.025	●	●	
20.000	20.000	19.500	104.000	38.000	52.000	3.000	4	20.030	●	●	
20.000	20.000	19.500	104.000	38.000	52.000	3.175	4	20.031	●	●	
20.000	20.000	19.500	104.000	38.000	52.000	4.000	4	20.040	●	●	
25.000	25.000	24.000	121.000	45.000	63.000	1.500	4	25.015	●	●	
25.000	25.000	24.000	121.000	45.000	63.000	2.000	4	25.020	●	●	
25.000	25.000	24.000	121.000	45.000	63.000	2.500	4	25.025	●	●	
25.000	25.000	24.000	121.000	45.000	63.000	3.000	4	25.030	●	●	
25.000	25.000	24.000	121.000	45.000	63.000	3.175	4	25.031	●	●	
25.000	25.000	24.000	121.000	45.000	63.000	4.000	4	25.040	●	●	
25.000	25.000	24.000	121.000	45.000	63.000	5.000	4	25.050	●	●	

ISO	Hardness	vc	fz (mm/z) / Ø							vc	fz (mm/z) / Ø						
			3	6	8	10	12	16	20		3	6	8	10	12	16	20
			ap = 1,0 x D				ae = 1,0 x D				ap = l2				ae max = 0,2 x D		
P	≤ 850 N/mm <sup>2</sup>	180	0,016	0,031	0,042	0,060	0,07	0,10	0,12	305	0,025	0,050	0,067	0,096	0,12	0,15	0,19
	≥ 850 N/mm <sup>2</sup>	135	0,014	0,027	0,036	0,050	0,06	0,08	0,10	230	0,022	0,043	0,058	0,080	0,10	0,13	0,16
M	≤ 750 N/mm <sup>2</sup>	120	0,014	0,027	0,036	0,050	0,06	0,08	0,10	205	0,022	0,043	0,058	0,080	0,10	0,13	0,16
	≥ 750 N/mm <sup>2</sup>	60	0,011	0,021	0,028	0,040	0,05	0,06	0,08	100	0,017	0,034	0,045	0,064	0,08	0,10	0,13
S	Ni-based	30	0,008	0,017	0,022	0,032	0,04	0,05	0,06	50	0,013	0,027	0,036	0,051	0,06	0,08	0,10
	Ti-based	60	0,012	0,024	0,032	0,045	0,05	0,07	0,09	100	0,019	0,038	0,051	0,072	0,09	0,12	0,14

Ratio end mills RF 100 Ti

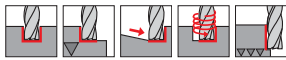
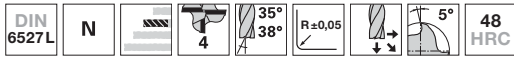

P	•
M	•
K	
N	
S	•
H	

**GÜHRING NAVIGATOR**

Cutting data page 34

- Zenit coating
- re-inforced core
- neck clearance
- centre cutting

Tool material	Solid carbide	
Surface	Z	Z
Type	N	N
Shank form	HA	HB

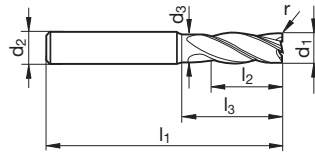



Article no. 6966 6967

Discount group 106 106

d1 h10	d2 h6	d3	l1	l2	l3	r	Z	Code no.	Availability
mm	mm	mm	mm	mm	mm	mm			
6.000	6.000	5.700	57.000	13.000	20.000	0.500	4	6.005	• •
6.000	6.000	5.700	57.000	13.000	20.000	0.800	4	6.008	• •
6.000	6.000	5.700	57.000	13.000	20.000	1.000	4	6.010	• •
6.000	6.000	5.700	57.000	13.000	20.000	1.500	4	6.015	• •
6.000	6.000	5.700	57.000	13.000	20.000	2.000	4	6.020	• •
8.000	8.000	7.700	63.000	19.000	26.000	0.500	4	8.005	• •
8.000	8.000	7.700	63.000	19.000	26.000	0.800	4	8.008	• •
8.000	8.000	7.700	63.000	19.000	26.000	1.000	4	8.010	• •
8.000	8.000	7.700	63.000	19.000	26.000	1.500	4	8.015	• •
8.000	8.000	7.700	63.000	19.000	26.000	2.000	4	8.020	• •
10.000	10.000	9.500	72.000	22.000	30.000	0.500	4	10.005	• •
10.000	10.000	9.500	72.000	22.000	30.000	0.800	4	10.008	• •
10.000	10.000	9.500	72.000	22.000	30.000	1.000	4	10.010	• •
10.000	10.000	9.500	72.000	22.000	30.000	1.500	4	10.015	• •
10.000	10.000	9.500	72.000	22.000	30.000	2.000	4	10.020	• •
12.000	12.000	11.500	83.000	26.000	36.000	0.500	4	12.005	• •
12.000	12.000	11.500	83.000	26.000	36.000	0.800	4	12.008	• •
12.000	12.000	11.500	83.000	26.000	36.000	1.000	4	12.010	• •
12.000	12.000	11.500	83.000	26.000	36.000	1.500	4	12.015	• •
12.000	12.000	11.500	83.000	26.000	36.000	2.000	4	12.020	• •
12.000	12.000	11.500	83.000	26.000	36.000	2.500	4	12.025	• •
12.000	12.000	11.500	83.000	26.000	36.000	3.000	4	12.030	• •
12.000	12.000	11.500	83.000	26.000	36.000	3.175	4	12.031	• •
12.000	12.000	11.500	83.000	26.000	36.000	4.000	4	12.040	• •
16.000	16.000	15.500	92.000	32.000	42.000	0.500	4	16.005	• •
16.000	16.000	15.500	92.000	32.000	42.000	0.800	4	16.008	• •
16.000	16.000	15.500	92.000	32.000	42.000	1.000	4	16.010	• •
16.000	16.000	15.500	92.000	32.000	42.000	1.500	4	16.015	• •
16.000	16.000	15.500	92.000	32.000	42.000	2.000	4	16.020	• •
16.000	16.000	15.500	92.000	32.000	42.000	2.500	4	16.025	• •



									Article no.	6966	6967
									Discount group	106	106
d1 h10	d2 h6	d3	l1	l2	l3	r	Z	Code no.	Availability		
mm	mm	mm	mm	mm	mm	mm					
16.000	16.000	15.500	92.000	32.000	42.000	3.000	4	16.030	●	●	
16.000	16.000	15.500	92.000	32.000	42.000	3.175	4	16.031	●	●	
16.000	16.000	15.500	92.000	32.000	42.000	4.000	4	16.040	●	●	
20.000	20.000	19.500	104.000	38.000	52.000	0.500	4	20.005	●	●	
20.000	20.000	19.500	104.000	38.000	52.000	1.000	4	20.010	●	●	
20.000	20.000	19.500	104.000	38.000	52.000	1.500	4	20.015	●	●	
20.000	20.000	19.500	104.000	38.000	52.000	2.000	4	20.020	●	●	
20.000	20.000	19.500	104.000	38.000	52.000	2.500	4	20.025	●	●	
20.000	20.000	19.500	104.000	38.000	52.000	3.000	4	20.030	●	●	
20.000	20.000	19.500	104.000	38.000	52.000	3.175	4	20.031	●	●	
20.000	20.000	19.500	104.000	38.000	52.000	4.000	4	20.040	●	●	
25.000	25.000	24.000	121.000	45.000	63.000	1.500	4	25.015	●	●	
25.000	25.000	24.000	121.000	45.000	63.000	2.000	4	25.020	●	●	
25.000	25.000	24.000	121.000	45.000	63.000	2.500	4	25.025	●	●	
25.000	25.000	24.000	121.000	45.000	63.000	3.000	4	25.030	●	●	
25.000	25.000	24.000	121.000	45.000	63.000	3.175	4	25.031	●	●	
25.000	25.000	24.000	121.000	45.000	63.000	4.000	4	25.040	●	●	
25.000	25.000	24.000	121.000	45.000	63.000	5.000	4	25.050	●	●	

ISO	Hardness	vc	fz (mm/z) / Ø							vc	fz (mm/z) / Ø						
			3	6	8	10	12	16	20		3	6	8	10	12	16	20
			ap = 1,0 x D				ae = 1,0 x D				ap = l2				ae max = 0,2 x D		
<b>P</b>	≤ 850 N/mm <sup>2</sup>	<b>180</b>	0,016	0,031	0,042	0,060	0,07	0,10	0,12	<b>305</b>	0,025	0,050	0,067	0,096	0,12	0,15	0,19
	≥ 850 N/mm <sup>2</sup>	<b>135</b>	0,014	0,027	0,036	0,050	0,06	0,08	0,10	<b>230</b>	0,022	0,043	0,058	0,080	0,10	0,13	0,16
<b>M</b>	≤ 750 N/mm <sup>2</sup>	<b>120</b>	0,014	0,027	0,036	0,050	0,06	0,08	0,10	<b>205</b>	0,022	0,043	0,058	0,080	0,10	0,13	0,16
	≥ 750 N/mm <sup>2</sup>	<b>60</b>	0,011	0,021	0,028	0,040	0,05	0,06	0,08	<b>100</b>	0,017	0,034	0,045	0,064	0,08	0,10	0,13
<b>S</b>	Ni-based	<b>30</b>	0,008	0,017	0,022	0,032	0,04	0,05	0,06	<b>50</b>	0,013	0,027	0,036	0,051	0,06	0,08	0,10
	Ti-based	<b>60</b>	0,012	0,024	0,032	0,045	0,05	0,07	0,09	<b>100</b>	0,019	0,038	0,051	0,072	0,09	0,12	0,14

**Standard Ratio end mills RF 100 U (3-fluted)**

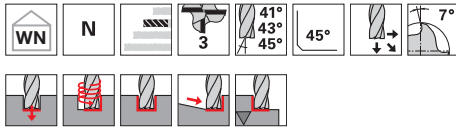

Tool material	<b>Solid carbide</b>
Surface	<b>R</b>
Type	N
Shank form	HB

**P** • **GÜHRING NAVIGATOR**

**M** • Cutting data page 34

**K**

**N** •

**S** •

**H**

- Raptor coating
- neck clearance
- centre cutting

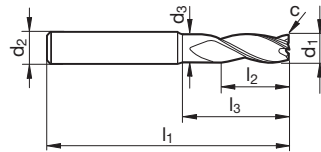

Article no. **6728**

Discount group **106**

d1 e8	d2 h6	d3	l1	l2	l3	c	Z	Code no.	Availability
mm	mm	mm	mm	mm	mm	mm x 45°			
3.000	6.000	2.800	57.000	8.000	15.000	0.050	3	3.000	•
4.000	6.000	3.800	57.000	11.000	18.000	0.060	3	4.000	•
6.000	6.000	5.700	57.000	13.000	20.000	0.090	3	6.000	•
8.000	8.000	7.700	63.000	19.000	26.000	0.120	3	8.000	•
10.000	10.000	9.500	72.000	22.000	30.000	0.150	3	10.000	•
12.000	12.000	11.500	83.000	26.000	36.000	0.180	3	12.000	•
16.000	16.000	15.500	92.000	32.000	42.000	0.190	3	16.000	•
20.000	20.000	19.500	104.000	38.000	52.000	0.240	3	20.000	•

ISO	Hardness	vc	fz (mm/z) / Ø						vc	fz (mm/z) / Ø							
			3	6	8	10	12	16		20	3	6	8	10	12	16	20
P	≤ 850 N/mm <sup>2</sup>	<b>180</b>	0,016	0,031	0,042	0,060	0,07	0,10	0,12	<b>210</b>	0,018	0,036	0,048	0,069	0,08	0,11	0,14
	≥ 850 N/mm <sup>2</sup>	<b>135</b>	0,014	0,027	0,036	0,050	0,06	0,08	0,10		<b>160</b>	0,016	0,031	0,041	0,058	0,07	0,09
M	≤ 750 N/mm <sup>2</sup>	<b>120</b>	0,014	0,027	0,036	0,050	0,06	0,08	0,10	<b>140</b>	0,016	0,031	0,041	0,058	0,07	0,09	0,12
	≥ 750 N/mm <sup>2</sup>	<b>60</b>	0,011	0,021	0,028	0,040	0,05	0,06	0,08		<b>80</b>	0,013	0,025	0,034	0,048	0,06	0,08
S	Ni-based	<b>30</b>	0,008	0,017	0,022	0,032	0,04	0,05	0,06	<b>40</b>	0,010	0,020	0,027	0,038	0,05	0,06	0,08
	Ti-based	<b>60</b>	0,012	0,024	0,032	0,045	0,05	0,07	0,09		<b>80</b>	0,014	0,029	0,038	0,054	0,06	0,09
N	≤ 5% Si	<b>500</b>	0,020	0,039	0,052	0,080	0,10	0,13	0,16	<b>600</b>	0,022	0,045	0,060	0,092	0,11	0,15	0,18
	≥ 5% Si	<b>230</b>	0,017	0,033	0,044	0,060	0,07	0,10	0,12		<b>300</b>	0,019	0,038	0,051	0,069	0,08	0,11





Ratio end mills RF 100 F

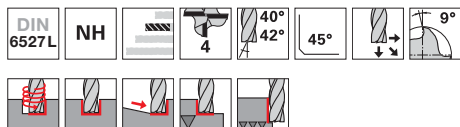

**P** • **GÜHRING NAVIGATOR**  
**M** • Cutting data page 34  
**K**   
**N** ○  
**S** • Raptor coating  
**H** • neck clearance  
 • centre cutting

Tool material	<b>Solid carbide</b>
Surface	<b>R</b>
Type	NH
Shank form	HB

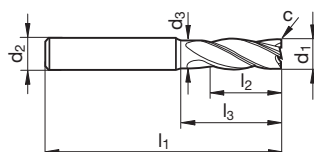

Article no. **6968**

Discount group **106**

d1 h10	d2 h6	d3	l1	l2	l3	c	Z	Code no.	Availability
mm	mm	mm	mm	mm	mm	mm x 45°			
4.000	6.000	3.800	57.000	11.000	18.000	0.100	4	4.000	●
5.000	6.000	4.800	57.000	13.000	18.000	0.100	4	5.000	●
6.000	6.000	5.700	57.000	13.000	20.000	0.150	4	6.000	●
8.000	8.000	7.700	63.000	19.000	26.000	0.150	4	8.000	●
10.000	10.000	9.500	72.000	22.000	30.000	0.200	4	10.000	●
12.000	12.000	11.500	83.000	26.000	36.000	0.200	4	12.000	●
16.000	16.000	15.500	92.000	32.000	42.000	0.350	4	16.000	●
20.000	20.000	19.500	104.000	38.000	52.000	0.450	4	20.000	●

ISO	Hardness	vc	fz (mm/z) / Ø							vc	fz (mm/z) / Ø						
			3	6	8	10	12	16	20		3	6	8	10	12	16	20
<b>P</b>	≤ 850 N/mm <sup>2</sup>	<b>180</b>	0,016	0,031	0,042	0,060	0,07	0,10	0,12	<b>305</b>	0,025	0,050	0,067	0,096	0,12	0,15	0,19
	≥ 850 N/mm <sup>2</sup>	<b>135</b>	0,014	0,027	0,036	0,050	0,06	0,08	0,10		<b>230</b>	0,022	0,043	0,058	0,080	0,10	0,13
<b>M</b>	≤ 750 N/mm <sup>2</sup>	<b>120</b>	0,014	0,027	0,036	0,050	0,06	0,08	0,10	<b>205</b>	0,022	0,043	0,058	0,080	0,10	0,13	0,16
	≥ 750 N/mm <sup>2</sup>	<b>60</b>	0,011	0,021	0,028	0,040	0,05	0,06	0,08		<b>100</b>	0,017	0,034	0,045	0,064	0,08	0,10
<b>S</b>	Ni-based	<b>30</b>	0,008	0,017	0,022	0,032	0,04	0,05	0,06	<b>50</b>	0,013	0,027	0,036	0,051	0,06	0,08	0,10
	Ti-based	<b>60</b>	0,012	0,024	0,032	0,045	0,05	0,07	0,09		<b>100</b>	0,019	0,038	0,051	0,072	0,09	0,12

Ratio end mills Superfinish RF 100 SF



**P** • **GÜHRING NAVIGATOR**

**M** • Cutting data page 34

**K** •

**N** •

**S** • Raptor coating

**H** • neck clearance

• centre cutting

Tool material **Solid carbide**

Surface **R**

Type **NH**

Shank form **HB**

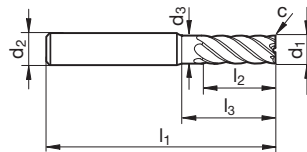

Article no. **6727**

Discount group **106**

d1 h10	d2 h6	d3	l1	l2	l3	c	Z	Code no.	Availability
mm	mm	mm	mm	mm	mm	mm x 45°			
8.000	8.000	7.700	63.000	19.000	26.000	0.100	6	8.000	●
10.000	10.000	9.500	72.000	22.000	30.000	0.100	6	10.000	●
12.000	12.000	11.500	83.000	26.000	36.000	0.100	6	12.000	●
16.000	16.000	15.500	92.000	32.000	42.000	0.150	6	16.000	●
20.000	20.000	19.500	104.000	38.000	52.000	0.150	6	20.000	●

ISO	Hardness	vc	fz (mm/z) / Ø							vc	fz (mm/z) / Ø						
			3	6	8	10	12	16	20		3	6	8	10	12	16	20
P	≤ 850 N/mm <sup>2</sup>	<b>340</b>	0,036	0,072	0,096	0,138	0,17	0,22	0,28	<b>360</b>	0,017	0,034	0,046	0,066	0,08	0,11	0,13
	≥ 850 N/mm <sup>2</sup>	<b>250</b>	0,031	0,062	0,083	0,115	0,14	0,18	0,23		<b>270</b>	0,015	0,030	0,040	0,055	0,07	0,09
M	≤ 750 N/mm <sup>2</sup>	<b>220</b>	0,031	0,062	0,083	0,115	0,14	0,18	0,23	<b>240</b>	0,015	0,030	0,040	0,055	0,07	0,09	0,11
	≥ 750 N/mm <sup>2</sup>	<b>110</b>	0,024	0,048	0,064	0,092	0,11	0,15	0,18		<b>120</b>	0,011	0,021	0,028	0,040	0,05	0,06
S	Ni-based	<b>60</b>	0,019	0,039	0,052	0,074	0,09	0,12	0,15	<b>60</b>	0,008	0,017	0,022	0,032	0,04	0,05	0,06
	Ti-based	<b>110</b>	0,028	0,055	0,074	0,104	0,12	0,17	0,21		<b>120</b>	0,013	0,026	0,035	0,050	0,06	0,08
N	≤ 7 % Si	<b>900</b>	0,045	0,090	0,120	0,184	0,22	0,29	0,37	<b>1000</b>	0,021	0,043	0,057	0,088	0,11	0,14	0,18
	≥ 7 % Si	<b>430</b>	0,038	0,076	0,101	0,138	0,17	0,22	0,28		<b>460</b>	0,018	0,036	0,048	0,066	0,08	0,11



Ratio end mills Superfinish RF 100 SF



**P** • **GÜHRING NAVIGATOR**  
**M** • Cutting data page 34  
**K** •  
**N** •  
**S** •  
**H** ○ • neck clearance  
           • centre cutting

Tool material	Solid carbide	
Surface	F	F
Type	NH	NH
Shank form	HA	HB

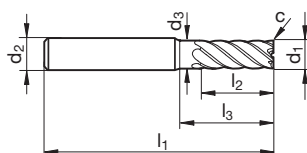

Article no.	<b>3631</b>	<b>3632</b>
Discount group	<b>106</b>	<b>106</b>

d1 h10	d2 h6	d3	l1	l2	l3	c	Z	Code no.	Availability
mm	mm	mm	mm	mm	mm	mm x 45°			
8.000	8.000	7.700	63.000	19.000	26.000	0.100	6	8.000	● ●
10.000	10.000	9.500	72.000	22.000	30.000	0.100	6	10.000	● ●
12.000	12.000	11.500	83.000	26.000	36.000	0.100	6	12.000	● ●
16.000	16.000	15.500	92.000	32.000	42.000	0.150	6	16.000	● ●
20.000	20.000	19.500	104.000	38.000	52.000	0.150	6	20.000	● ●
25.000	25.000	24.000	121.000	45.000	63.000	0.200	6	25.000	● ●

ISO	Hardness	vc	fz (mm/z) / Ø							vc	fz (mm/z) / Ø						
			3	6	8	10	12	16	20		3	6	8	10	12	16	20
P	≤ 850 N/mm <sup>2</sup>	<b>340</b>	0,036	0,072	0,096	0,138	0,17	0,22	0,28	<b>360</b>	0,017	0,034	0,046	0,066	0,08	0,11	0,13
	≥ 850 N/mm <sup>2</sup>	<b>250</b>	0,031	0,062	0,083	0,115	0,14	0,18	0,23		<b>270</b>	0,015	0,030	0,040	0,055	0,07	0,09
M	≤ 750 N/mm <sup>2</sup>	<b>220</b>	0,031	0,062	0,083	0,115	0,14	0,18	0,23	<b>240</b>	0,015	0,030	0,040	0,055	0,07	0,09	0,11
	≥ 750 N/mm <sup>2</sup>	<b>110</b>	0,024	0,048	0,064	0,092	0,11	0,15	0,18		<b>120</b>	0,011	0,021	0,028	0,040	0,05	0,06
S	Ni-based	<b>60</b>	0,019	0,039	0,052	0,074	0,09	0,12	0,15	<b>60</b>	0,008	0,017	0,022	0,032	0,04	0,05	0,06
	Ti-based	<b>110</b>	0,028	0,055	0,074	0,104	0,12	0,17	0,21		<b>120</b>	0,013	0,026	0,035	0,050	0,06	0,08
K	≤ 240 HB	<b>300</b>	0,038	0,076	0,101	0,150	0,18	0,24	0,30	<b>320</b>	0,018	0,036	0,048	0,072	0,09	0,11	0,14
	≥ 240 HB	<b>260</b>	0,035	0,069	0,092	0,127	0,15	0,20	0,25		<b>280</b>	0,017	0,033	0,044	0,061	0,07	0,10
N	≤ 7 % Si	<b>900</b>	0,045	0,090	0,120	0,184	0,22	0,29	0,37	<b>1000</b>	0,021	0,043	0,057	0,088	0,11	0,14	0,18
	≥ 7 % Si	<b>430</b>	0,038	0,076	0,101	0,138	0,17	0,22	0,28		<b>460</b>	0,018	0,036	0,048	0,066	0,08	0,11

Ratio end mills Superfinish RF 100 SF



- P** •
- M** •
- K** •
- N** •
- S** •
- H** ○

**GÜHRING** NAVIGATOR

Cutting data page 34

- neck clearance
- centre cutting

Tool material	Solid carbide	
Surface	<b>F</b>	<b>F</b>
Type	NH	NH
Shank form	HA	HB

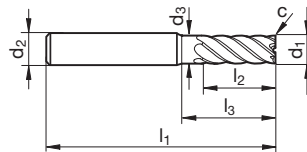

Article no.	<b>6709</b>	<b>6710</b>
Discount group	<b>106</b>	<b>106</b>

d1 h10	d2 h6	d3	l1	l2	l3	c	Z	Code no.	Availability
mm	mm	mm	mm	mm	mm	mm x 45°			
4.000	6.000	3.800	57.000	11.000	18.000	0.050	5	4.000	• •
5.000	6.000	4.800	57.000	13.000	18.000	0.050	5	5.000	• •
6.000	6.000	5.700	57.000	13.000	20.000	0.050	5	6.000	• •
8.000	8.000	7.700	63.000	19.000	26.000	0.100	5	8.000	• •
10.000	10.000	9.500	72.000	22.000	30.000	0.100	5	10.000	• •
12.000	12.000	11.500	83.000	26.000	36.000	0.100	5	12.000	• •
16.000	16.000	15.500	92.000	32.000	42.000	0.150	5	16.000	• •
20.000	20.000	19.500	104.000	38.000	52.000	0.150	5	20.000	• •
25.000	25.000	24.000	121.000	45.000	63.000	0.200	5	25.000	• •

ISO	Hardness	vc	fz (mm/z) / Ø							vc	fz (mm/z) / Ø						
			3	6	8	10	12	16	20		3	6	8	10	12	16	20
<b>P</b>	≤ 850 N/mm <sup>2</sup>	<b>340</b>	0,036	0,072	0,096	0,138	0,17	0,22	0,28	<b>360</b>	0,017	0,034	0,046	0,066	0,08	0,11	0,13
	≥ 850 N/mm <sup>2</sup>	<b>250</b>	0,031	0,062	0,083	0,115	0,14	0,18	0,23		<b>270</b>	0,015	0,030	0,040	0,055	0,07	0,09
<b>M</b>	≤ 750 N/mm <sup>2</sup>	<b>220</b>	0,031	0,062	0,083	0,115	0,14	0,18	0,23	<b>240</b>	0,015	0,030	0,040	0,055	0,07	0,09	0,11
	≥ 750 N/mm <sup>2</sup>	<b>110</b>	0,024	0,048	0,064	0,092	0,11	0,15	0,18		<b>120</b>	0,011	0,021	0,028	0,040	0,05	0,06
<b>S</b>	Ni-based	<b>60</b>	0,019	0,039	0,052	0,074	0,09	0,12	0,15	<b>60</b>	0,008	0,017	0,022	0,032	0,04	0,05	0,06
	Ti-based	<b>110</b>	0,028	0,055	0,074	0,104	0,12	0,17	0,21		<b>120</b>	0,013	0,026	0,035	0,050	0,06	0,08
<b>K</b>	≤ 240 HB	<b>300</b>	0,038	0,076	0,101	0,150	0,18	0,24	0,30	<b>320</b>	0,018	0,036	0,048	0,072	0,09	0,11	0,14
	≥ 240 HB	<b>260</b>	0,035	0,069	0,092	0,127	0,15	0,20	0,25		<b>280</b>	0,017	0,033	0,044	0,061	0,07	0,10
<b>N</b>	≤ 7 % Si	<b>900</b>	0,045	0,090	0,120	0,184	0,22	0,29	0,37	<b>1000</b>	0,021	0,043	0,057	0,088	0,11	0,14	0,18
	≥ 7 % Si	<b>430</b>	0,038	0,076	0,101	0,138	0,17	0,22	0,28		<b>460</b>	0,018	0,036	0,048	0,066	0,08	0,11



Ratio end mills Superfinish RF 100 SF



**P** • **GÜHRING NAVIGATOR**  
**M** • Cutting data page 34  
**K** •  
**N** •  
**S** •  
**H** ○ • neck clearance  
           • centre cutting

Tool material	Solid carbide	
Surface	F	F
Type	NH	NH
Shank form	HA	HB

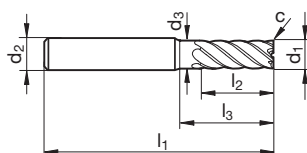

Article no.	3897	3898
Discount group	106	106

d1 h10	d2 h6	d3	l1	l2	l3	c	Z	Code no.	Availability
mm	mm	mm	mm	mm	mm	mm x 45°			
4.000	6.000	3.800	65.000	12.000	26.000	0.050	5	4.000	● ●
5.000	6.000	4.800	65.000	15.000	26.000	0.050	5	5.000	● ●
6.000	6.000	5.700	65.000	18.000	28.000	0.050	5	6.000	● ●
8.000	8.000	7.700	75.000	24.000	38.000	0.100	5	8.000	● ●
10.000	10.000	9.500	80.000	30.000	38.000	0.100	5	10.000	● ●
12.000	12.000	11.500	93.000	36.000	46.000	0.100	5	12.000	● ●
16.000	16.000	15.500	108.000	48.000	58.000	0.150	5	16.000	● ●
20.000	20.000	19.500	126.000	60.000	74.000	0.150	5	20.000	● ●

ISO	Hardness	vc	fz (mm/z) / Ø							vc	fz (mm/z) / Ø						
			3	6	8	10	12	16	20		3	6	8	10	12	16	20
P	≤ 850 N/mm <sup>2</sup>	340	0,036	0,072	0,096	0,138	0,17	0,22	0,28	360	0,017	0,034	0,046	0,066	0,08	0,11	0,13
	≥ 850 N/mm <sup>2</sup>	250	0,031	0,062	0,083	0,115	0,14	0,18	0,23	270	0,015	0,030	0,040	0,055	0,07	0,09	0,11
M	≤ 750 N/mm <sup>2</sup>	220	0,031	0,062	0,083	0,115	0,14	0,18	0,23	240	0,015	0,030	0,040	0,055	0,07	0,09	0,11
	≥ 750 N/mm <sup>2</sup>	110	0,024	0,048	0,064	0,092	0,11	0,15	0,18	120	0,011	0,021	0,028	0,040	0,05	0,06	0,08
S	Ni-based	60	0,019	0,039	0,052	0,074	0,09	0,12	0,15	60	0,008	0,017	0,022	0,032	0,04	0,05	0,06
	Ti-based	110	0,028	0,055	0,074	0,104	0,12	0,17	0,21	120	0,013	0,026	0,035	0,050	0,06	0,08	0,10
K	≤ 240 HB	300	0,038	0,076	0,101	0,150	0,18	0,24	0,30	320	0,018	0,036	0,048	0,072	0,09	0,11	0,14
	≥ 240 HB	260	0,035	0,069	0,092	0,127	0,15	0,20	0,25	280	0,017	0,033	0,044	0,061	0,07	0,10	0,12
N	≤ 7 % Si	900	0,045	0,090	0,120	0,184	0,22	0,29	0,37	1000	0,021	0,043	0,057	0,088	0,11	0,14	0,18
	≥ 7 % Si	430	0,038	0,076	0,101	0,138	0,17	0,22	0,28	460	0,018	0,036	0,048	0,066	0,08	0,11	0,13

## Efficient milling with the correct strategies

### GTC milling strategies

These milling strategies belong to the state-of-the-art and most effective application methods for current solid carbide milling tools. When applied, an enormously high metal removal rate ensures a considerable increase in productivity. Very high cutting parameters can be achieved even with less powerful machines or unstable machining conditions. With difficult-to-machine materials or unfavourable diameter-length-ratios of the tools a massive increase of process reliability can be achieved.

**HPC**

### HIGH PERFORMANCE CUTTING

max. metal removal rate/time → stable conditions; short de-clamping; high performance; good cooling

**HSC**

### HIGH SPEED CUTTING

at high speed/high feed rate → high dynamics; low cutting depth; low drive power

### Principles and objectives

#### Maximum tool utilisation

- utilisation of entire cutting edge length
- full power delivery
- increased tool life
- balanced wear

#### Modification of cutting distribution

- low cutting widths  $a_e$
- high cutting depths  $a_p$

#### High process reliability

- low tool wrapping
- improved thermal conditions at tool cutting edge
- low mechanical stress

#### Maximum metal removal rate

- saving time/machine costs





## Foundations for economically efficient milling

### Peripheral requirements

#### Applicable in every material group

- 
- easy to machine materials = increase in productivity
- difficult to machine materials = increase in process reliability

#### High-dynamic machining centres

- short acceleration distances
- higher speed range
- small to medium tool diameters

#### Heavy machines

- stable feed axes
- high spindle torque
- medium to large tool diameters

#### Unstable to stable workpiece clamping

- stable = vibration-free machining = maximum metal removal rate
- unstable = reduction of radial forces = increased process reliability

### Application parameters

#### Low cutting width $a_e$ to $0.33 \times D$

- low angle of engagement  $< 70^\circ$
- short time of contact between cutting edge and component

#### Very high tooth feed $f_z$

- reduced chip thickness allows considerably higher  $f_z$

#### Very high cutting speed $v_c$

- reduced heating up and prolonged cooling down allow very high  $v_c$  values

#### High cutting depth $a_p$

- improved leverage effect
- high metal removal rate
- increase in contact points between tool and component

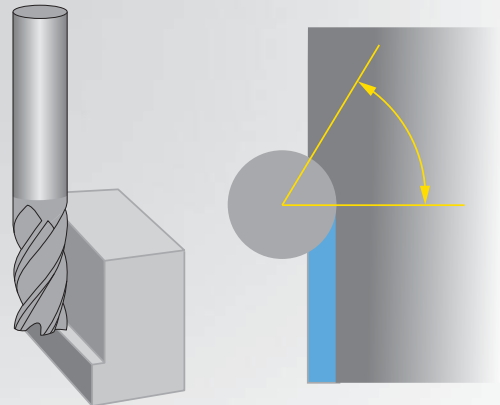

Tool angle of engagement & tool contact time

### Metal removal rate

The metal removal rate specifies how high the actual chip removal is per minute. It is especially suitable for comparing different machining strategies.

$$a_p \text{ (mm)} \times a_e \text{ (mm)} \times v_f \text{ (m/min)} = Q \text{ (cm}^3\text{/min)}$$

## Influence on process through tool engagement

### Angle of engagement

The angle of engagement inscribes the cutting range of the tool from start of chip formation to exit from the material. With these parameters the stress impacting on the tool can be assessed. With straight milling paths the angle is constant, with concave milling paths it increases and with convex milling paths it decreases.

#### Straight milling path

- constant angle of engagement
- constant tool stress

Example:  $a_e 0.20xD = 53^\circ$  engagement  
Engagement remains a constant  $53^\circ$

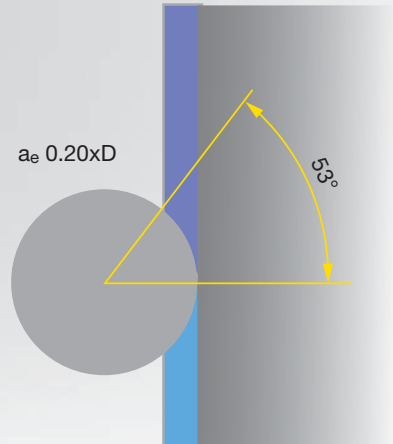

### Angle of engagement with convex contour radii

#### Convex milling path

- decreasing angle of engagement
- reduced tool stress

Example:  $a_e 0.20xD = 53^\circ$  engagement  
Engagement reduces to  $45^\circ$

Measures:  $a_e$  may be increased  
 $f_z$  can be increased

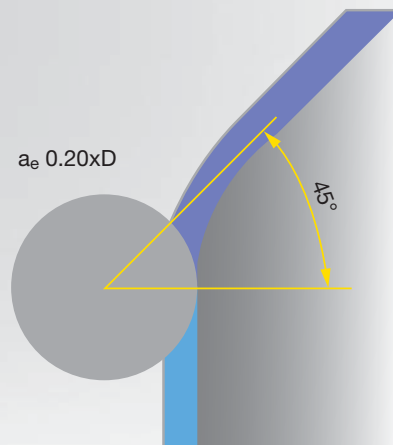

### Angle of engagement with concave contour radii

#### Concave milling path

- increasing angle of engagement
- increased tool stress

Example:  $a_e 0.20xD = 53^\circ$  engagement  
Engagement increases to  $74^\circ$

Measures:  $a_e$  must be reduced  
 $f_z$  must be reduced in radius

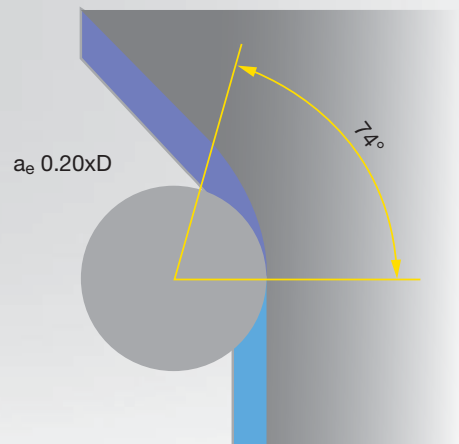





## Influence on process through tool engagement

### Angle of engagement with 90° corner radii

#### Tool radius = Corner radius

- very unfavourable for tool dynamics
- change of stress direction
- abrupt increase in tool stress

Example: Increase of engagement angle from 53° to 143° (270 %)

Measures:  $v_c$  and  $f_z$  must be heavily reduced

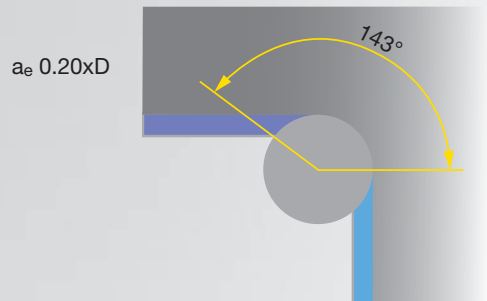

#### Tool radius < Corner radius

- machine can interpolate the path
- no "impact" on tool
- lower increase of tool stress

Example: Increase of engagement angle from 53° to 92° (174 %)

Measures:  $a_e$  must be reduced  
 $f_z$  must be heavily reduced in radius

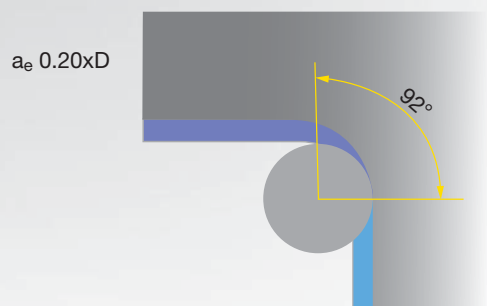

### Ratio of flute width to tool diameter with trochoidal milling



#### Flute width 1.7-2.0xD

- cut in C-arc
- $a_e$  max. 0.10xD (theor. 37°)
- increase of angles of engagement by up to 50 %

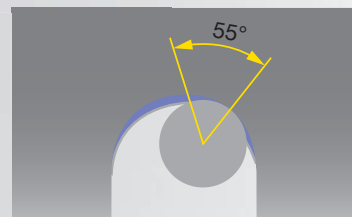

#### Flute width 2.1-3.0xD

- cut in C-arc
- $a_e$  max. 0.15xD (theor. 46°)
- increase of angles of engagement by up to 50 %

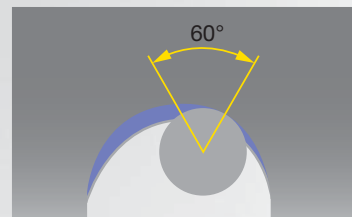

#### Flute width 3.1xD

- cut in D-arc
- $a_e$  max. 0.20xD (theor. 53°)
- increase of angles of engagement by up to 40 %

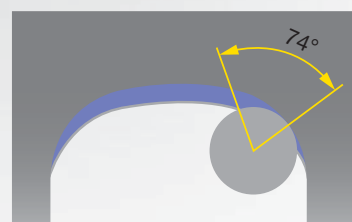



Guide values for increasing the cutting values with cutting edge lengths up to 3xD

GTC HPC HSC Roughing and HSC finishing

Material	Application	radial feed in % of Ø	v <sub>c</sub> factor *	f <sub>z</sub> factor *	Angle of engagement
	<b>Slotting</b>	<b>100%</b>	<b>1</b>	<b>1</b>	<b>180°</b>
	HPC Roughing	33%	1.5	1.3	70°
	HPC Roughing	25%	1.6	1.5	60°
	HPC Roughing	20%	1.7	1.6	53°
	HPC Roughing	15%	1.8	1.9	46°
	HSC Roughing	10%	1.9	2.3	37°
	HSC Roughing	8%	2.0	2.5	31°
	HSC Roughing	5%	2.1	2.5	26°
	HSC Finishing	3%	2.0	1.2	20°
	HSC Finishing	2%	2.0	1.1	18°
	HSC Finishing	1%	2.0	1.0	11°
	HSC fine finishing	0.5%	2.2	0.9	8°

\* base value for the calculation with v<sub>c</sub> and f<sub>z</sub> factors is the value specified in the Gühring Navigator for "slotting" in the respective material group.



Base cutting values slotting – RF 100 tools – smooth cutting

Material	Hardness	Application	v <sub>c</sub>	f <sub>z</sub> (mm/z) with nom. Ø									
				3	4	5	6	8	10	12	16	20	25
P1	≤ 850 N/mm <sup>2</sup>	Slotting	180	0.015	0.020	0.025	0.030	0.040	0.060	0.072	0.096	0.120	0.150
P2	850-1200 N/mm <sup>2</sup>	Slotting	160	0.014	0.019	0.024	0.029	0.038	0.055	0.066	0.088	0.110	0.138
P3	850-1400 N/mm <sup>2</sup>	Slotting	135	0.014	0.018	0.023	0.027	0.036	0.050	0.060	0.080	0.100	0.125
M1	< 750 N/mm <sup>2</sup>	Slotting	120	0.014	0.018	0.023	0.027	0.036	0.050	0.060	0.080	0.100	0.125
M2	750-850 N/mm <sup>2</sup>	Slotting	80	0.012	0.016	0.020	0.024	0.032	0.045	0.054	0.072	0.090	0.113
M3	> 850 N/mm <sup>2</sup>	Slotting	70	0.011	0.014	0.018	0.021	0.028	0.040	0.048	0.064	0.080	0.100
S-Ni	≤ 1300 N/mm <sup>2</sup>	Slotting	30	0.008	0.011	0.014	0.017	0.022	0.032	0.038	0.051	0.064	0.080
S-Ti	≤ 1300 N/mm <sup>2</sup>	Slotting	60	0.012	0.016	0.020	0.024	0.032	0.045	0.054	0.072	0.090	0.113
K1	≤ 240 HB	Slotting	160	0.017	0.022	0.028	0.033	0.044	0.065	0.078	0.104	0.130	0.163
K2	> 240 HB	Slotting	140	0.015	0.020	0.025	0.030	0.040	0.055	0.066	0.088	0.110	0.138
Wr. al.alloy	≤ 5% Si	Slotting	500	0.020	0.026	0.033	0.039	0.052	0.075	0.090	0.120	0.150	0.188
Cast al. alloy	> 5% Si	Slotting	230	0.017	0.022	0.028	0.033	0.044	0.060	0.072	0.096	0.120	0.150
Non-fer.metals	≤ 850 N/mm <sup>2</sup>	Slotting	250	0.017	0.022	0.028	0.033	0.044	0.060	0.072	0.096	0.120	0.150

Metal removal rate  $a_p$  (mm) X  $a_e$  (mm) X  $v_f$  (m/min) = Q (cm<sup>3</sup>/min)

Example:	HPC roughing: 15% a <sub>e</sub> ; 2xD a <sub>p</sub> ; C45
Tool:	RF 100 U Ø12 mm - 4 flutes
Feed:	radial feed a <sub>e</sub> 1.8 mm = 15% of D
Base value slotting	v <sub>c</sub> slotting = 180 m/min, f <sub>z</sub> slotting= 0.072 mm
Conversion:	v <sub>c</sub> factor = 1.8 → v <sub>c</sub> : 180 m/min x 1.8 = v <sub>c</sub> 324 m/min f <sub>z</sub> factor = 1.9 → f <sub>z</sub> : 0.072 mm x 1.9 = f <sub>z</sub> 0.137
Increased values:	v <sub>c</sub> : 324 m/min / f <sub>z</sub> : 0.137 mm n: 8594 U/min / v <sub>f</sub> : 4710 mm/min
Metal removal rate:	Q = 203 cm <sup>3</sup> /min



## GTC milling – fully optimised application examples

### Application example – material 16MnCr5

RF 100 Speed, #6761, Ø16 mm,  
HPC clamping chuck + PINLock-safety  
 $v_c$  410 m/min       $f_z$  0.450 mm       $h_m$  0.123 mm  
 $a_e$  1.2 mm       $a_p$  45 mm       $v_f$  14690 mm/min  
**Q = 793 cm<sup>3</sup>/min**

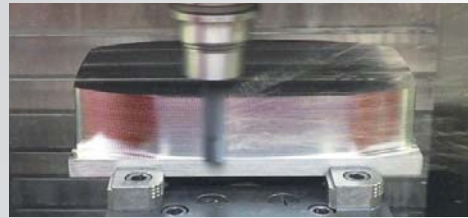

### Application example – material Hardox 400®

RF 100 U, #3871, Ø20 mm,  
Weldon clamping chuck  
 $v_c$  200 m/min       $f_z$  0.180 mm       $h_m$  0.049 mm  
 $a_e$  1.5 mm       $a_p$  55 mm       $v_f$  2290 mm/min  
**Q = 189 cm<sup>3</sup>/min**



## GTC milling – Strategy comparison

### Application comparison – material 42CrMo4

#### Gühring

RF 100 Diver, #6736, Ø12-Z4,  
Weldon clamping chuck  
 $v_c$  300 m/min       $f_z$  0.120 mm  
 $n$  7960 U/min       $v_f$  3820 mm/min  
 $a_e$  1.5 mm       $a_p$  24 mm  
**Q = 138 cm<sup>3</sup>/min**

5 radial cuts per 1200 mm Weg  
Machining time = **1.34 min**



### Application comparison – material 42CrMo4

#### Competition

HPC milling cutter, Ø16-Z4  
Weldon clamping chuck  
 $v_c$  140 m/min       $f_z$  0.070 mm  
 $n$  2790 U/min       $v_f$  780 mm/min  
 $a_e$  7.5 mm       $a_p$  12 mm  
**Q = 70 cm<sup>3</sup>/min**

2 axial cuts per 1200 mm Weg  
Machining time = 3.05 min



### Application comparison – material 1.4301

#### Gühring

RF 100 SF, #3632, Ø16-Z6,  
Weldon clamping chuck  
 $v_c$  160 m/min       $f_z$  0.100 mm  
 $n$  3185 U/min       $v_f$  1910 mm/min  
 $a_e$  1.2 mm       $a_p$  30 mm  
**Q = 69 cm<sup>3</sup>/min**

10 radial cuts per 900 mm Weg  
Machining time = **4.43 min**



### Application comparison – material 1.4301

#### Competition

Indexable inserted milling cutter Ø25-Z3  
 $v_c$  200 m/min       $f_z$  0.120 mm  
 $n$  2550 U/min       $v_f$  920 mm/min  
 $a_e$  12 mm       $a_p$  2 mm  
**Q = 22 cm<sup>3</sup>/min**

15 axial cuts per 900 mm Weg  
Machining time = 14.40 min

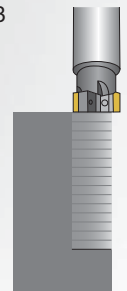



Drilling

Tapping/Thread milling/  
Fluteless tapping

Milling

Countersinking

Reaming

PCD

Services

Grooving systems

Special solutions

Modular systems

# GÜHRING

P.O. Box 100247 • 72423 Albstadt  
Herderstrasse 50-54 • 72458 Albstadt

T +49 74 31 17-0  
F +49 74 31 17-21279

info@guehring.de  
www.guehring.de

No liability can be accepted for printing errors or technical changes of any kind.  
Our Conditions of Sale and Terms of Payment apply. Available on request.